

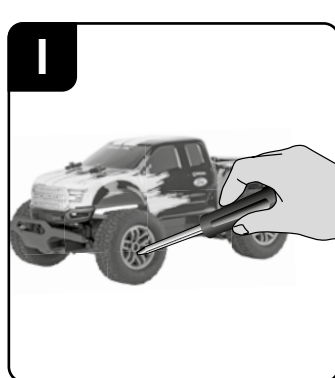

Sicherheitsbestimmungen · Safety instructions  
Consignes de sécurité · Disposiciones de seguridad  
Norme di sicurezza · Veiligheidsbepalingen  
Prescrições de segurança · Säkerhetsbestämmelser  
Turvallisuusohjeet · Zasady bezpieczeństwa  
Biztonsági rendelkezések · Varnostna določila  
Bezpečnostní předpisy · Bezpečnostné predpisy  
Sikkerhetsbestemmelser · Sikkerhedsbestemmelser  
أنظمة السلامة · Διατάξεις ασφαλείας · 安全准则 · 안전수칙

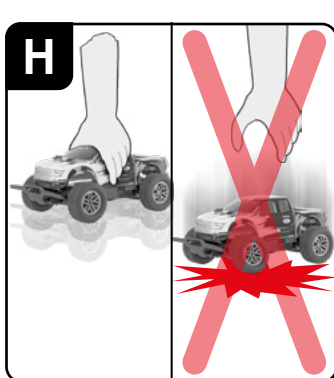
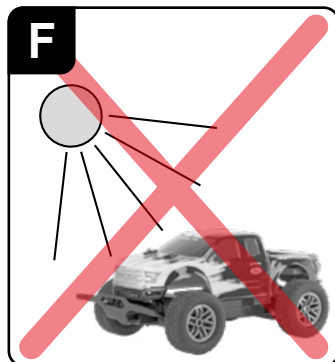
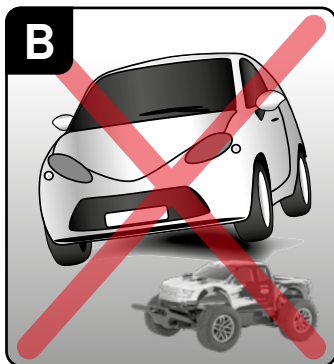

**1**

**6,4 V 700 mAh!  
4,48 Wh LiFePO<sub>4</sub>**



**2x 1.5 V Micro AAA batteries  
2x Piles 1,5 V micro AAA  
2x Pilas de 1,5 V Micro AAA**



Ford Motor Company  
Trademarks and Trade  
Dress used under license  
to Carrera Toys GmbH

**2****1**

**2** 6,4 V 700 mAh!  
4,48 Wh LiFePO<sub>4</sub>



Green = Connection OK  
Vert = Connexion OK  
Verde = Conexión OK

LED OFF = Charging  
DEL OFF = En charge  
LED OFF = Cargando

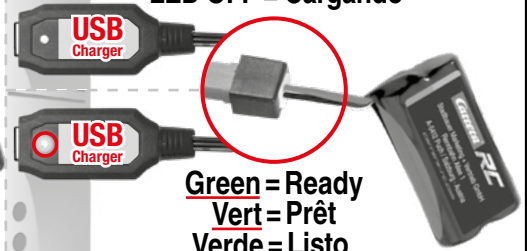

Green = Ready  
Vert = Prêt  
Verde = Listo

**3**

**1x 6,4 V 700 mAh!  
4,48 Wh LiFePO<sub>4</sub>**

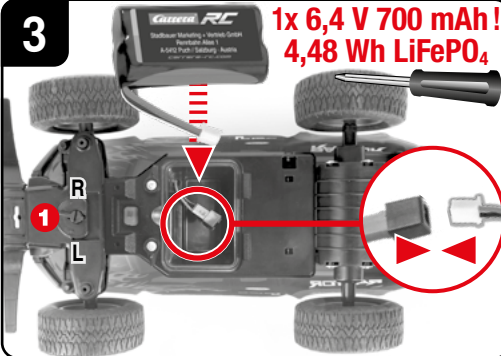
**4**

**2x 1.5 V Micro AAA batteries  
2x Piles 1,5 V micro AAA  
2x Pilas de 1,5 V Micro AAA**

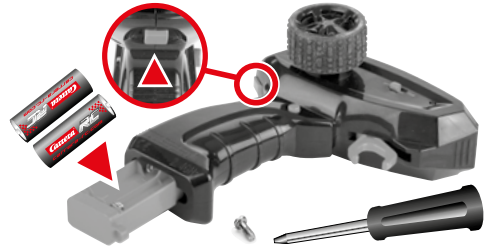
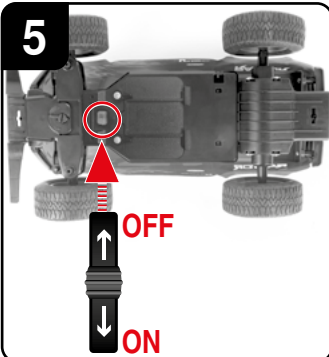
**5**

↑ OFF  
↓ ON

**6**

OFF  ON

**7**